

VOYGAR SERVER 19" FLOOR MOUNTED Type 800x1000MM CABINET

VOYGAR SERVER CABINET series are designed to provide maximum performance with a professional technical and aesthetic look for a wide range of applications in the data, security, audio visual and telecommunication field and available in range of heights and depths.

Enhanced Strength, ease of use and aesthetics are priorities of SERVER CABINET design. Each cabinet has a ventilated roof for better air circulation. Fully adjustable front and rear profile rails and large cable entries of the cabinet, make this product extremely attractive to installers who needs server cabinet.

Each rack consists of up to 1.5 mm strong steel sheet material which ensures a very good stability as a robust steel construction due to special plate curving technique and a load capacity up to 600kg can be reached. Sliding balance bars with leveling feet in front provides better stability based on center of gravity. An extensive accessories portfolio for plinths, shelves, cable management, etc. will help to meet many requirements in daily use.



General Features

- Safety class rating IP20
- Sliding balance bars with leveling feet in front
- Ventilated roofs makes air circulation better and reaching fan modules easier
- Roof corners are closed with plastic corner
- Swing handle lock fitted perforated front door and rear door
- Full height front and rear adjustable galvanized steel 19" profiles
- 19" profiles marked with U height position
- Large cut out in base and roof for cable entry
- Roof is prepared for fan units (punched out entries)

General Specifications

Load Capacity (kg)	1000kg
Front Cover	Perforated
Front door	single or double opening with 120° angle
Rear Cover	Perforated
Rear door	single or double opening with 120° angle
Side panels	2x sliding lock and a key lock and easily detachable
Paint Specification	RAL 7035 or RAL 9005
Top sachet	3*70mmx316mm Brushed cable entry.
Bottom sachet	3*70mmx316mm Brushed cable entry.
Available Sizes	26U up to 47U

Rack Drawings

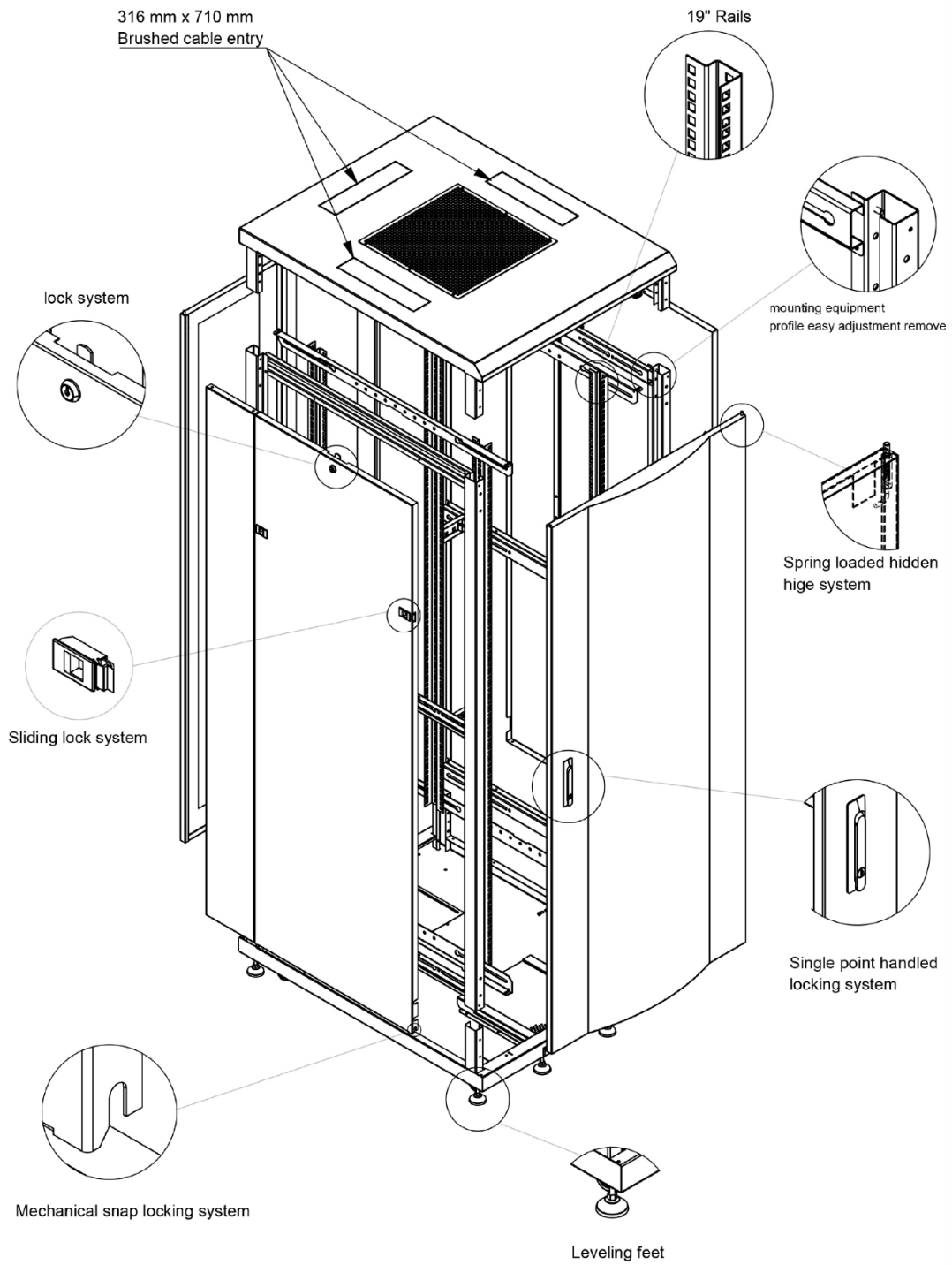

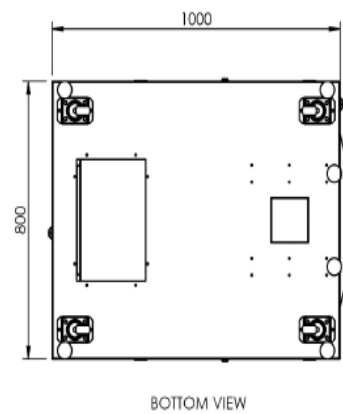
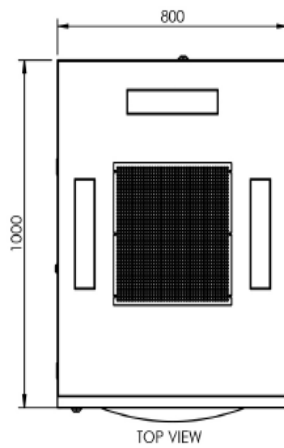
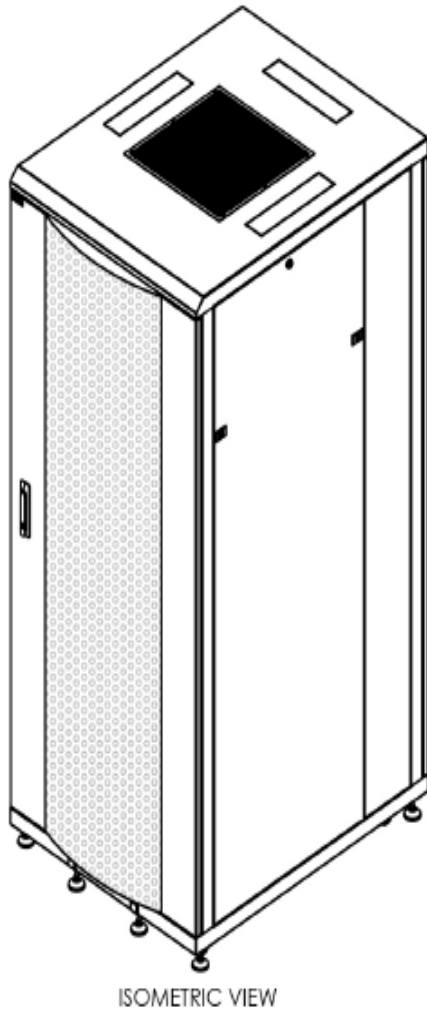
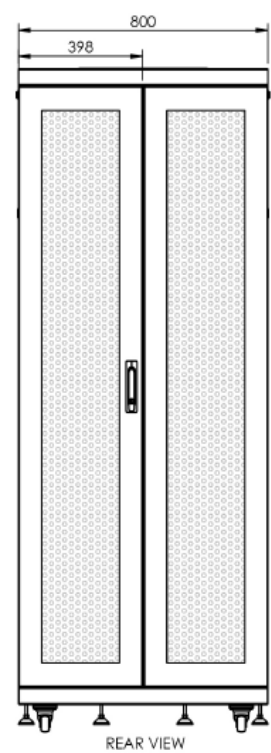
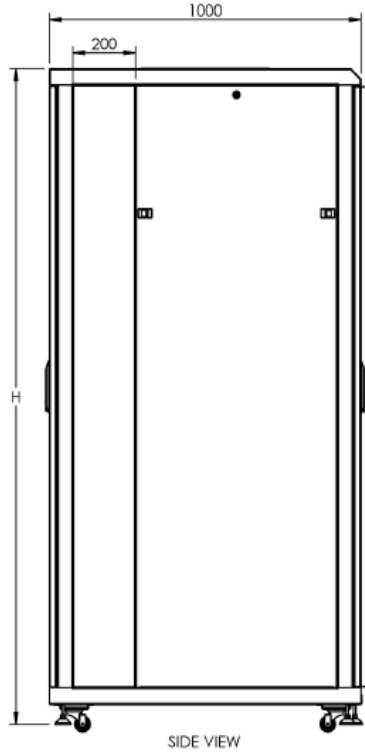
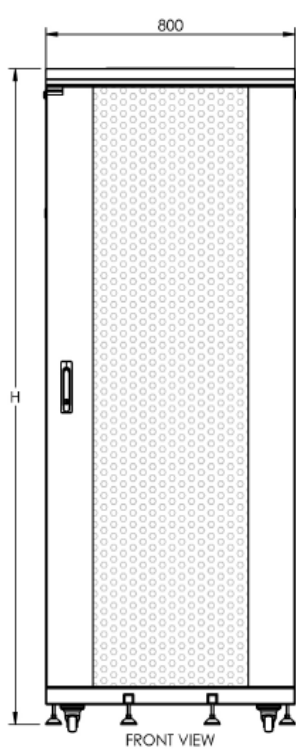

Ordering Information

SERVER FLOOR MOUNTED W=800mm D=1000mm

PRODUCT CODE	PRODUCT DESCRIPTION	RAL	HEIGHT (mm)	WIDTH(mm)	DEPTH(mm)	PRODUCT WEIGHT (kg)
SP1P180126	VOYGAR SERVER 19" FLOOR MOUNTED Type 26U 800x1000MM CABINET	7035 /9005	1292	800	1000	87,2
SP1P180132	VOYGAR SERVER 19" FLOOR MOUNTED Type 32U 800x1000MM CABINET	7035 /9005	1558	800	1000	98,4
SP1P180136	VOYGAR SERVER 19" FLOOR MOUNTED Type 36U 800x1000MM CABINET	7035 /9005	1736	800	1000	104,3
SP1P180139	VOYGAR SERVER 19" FLOOR MOUNTED Type 39U 800x1000MM CABINET	7035 /9005	1870	800	1000	110,9
SP1P180142	VOYGAR SERVER 19" FLOOR MOUNTED Type 42U 800x1000MM CABINET	7035 /9005	2003	800	1000	117,4
SP1P180144	VOYGAR SERVER 19" FLOOR MOUNTED Type 44U 800x1000MM CABINET	7035 /9005	2092	800	1000	123,7
SP1P180147	VOYGAR SERVER 19" FLOOR MOUNTED Type 47U 800x1000MM CABINET	7035 /9005	2225	800	1000	129,2

PDUS SCHUKO SOCKET SWITCHED

PN	Description
HPD1SKSK04	19Inch PDU 4 SCHUKO SOCKET SWITCHED 16AMP LED INDIC
HPD1SKSK05	19Inch PDU 5 SCHUKO SOCKET SWITCHED 16AMP LED INDIC
HPD1SKSK06	19Inch PDU 6 SCHUKO SOCKET SWITCHED 16AMP LED INDIC
HPD1SKSK08	19Inch PDU 8 SCHUKO SOCKET SWITCHED 16AMP LED INDIC

FAN MODULE

PN	Description
FANSWR02	2 Fan Module ON/OFF Switched Free Standing Type
FANSWR04	4 Fan Module ON/OFF Switched Free Standing Type

BASE AND FLOOR FIXING MODULE

PN	Description
SHFX1100/SHFX2100	19" D:1000 1/2U FIXED SHELF
SHSL1100	19" D:1000 1U SLIDING SHELF